

DIMENSIONS FOR INTEGRAL HOUSING
MEETS NEMA 1-5, (4X), 7, 9, & 12

CERTIFIED	by _____				COPYRIGHT 1998
PO #	_____				DREXELBROOK ENG CO.
ENG	_____				SCALE NONE
USER	_____				UNLESS OTHERWISE STATED ALL DIMENSIONS IN INCHES (MM)
		2	9-98-244	GLM 10-1-98	DR. JJS 9-18-98
		1	5-96-342	GLM 10-21-96	CK. ASK
DE #	_____	ISS.	EDO/DSR NO.	APP'D	DATE

DREXELBROOK
Engineering Company

205 KEITH VALLEY RD
HORSHAM, PA 19044-9986

215-674-1234
FAX 215-674-2731

INTEGRAL 24 VDC
DUAL VERIGAP SWITCH
MOUNTING

504-1160-1-CD1

SHT. 1 OF 2
ISS. 2

440-115-184 (2)

NO. 504-1160-1-CD1

SHT. 1 OF 2

ALARM RELAY (DPDT)
(TYPICAL TWO BOARDS)

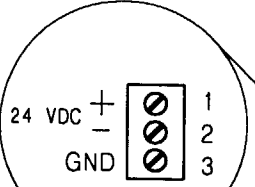
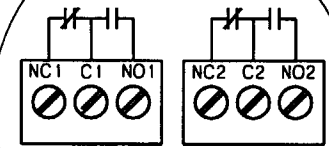

D.C. SUPPLY
24 VDC
(TYPICAL TWO BOARDS)

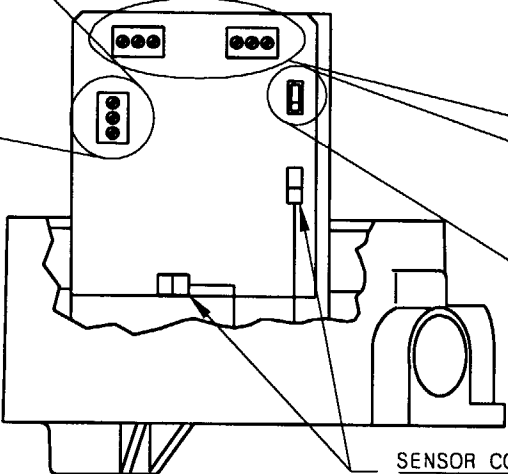

SENSOR CONNECTIONS
(TYPICAL TWO BOARDS)

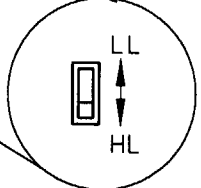

FAIL SAFE SWITCH

SENSOR WIRE
WITH **BLACK** HEAT SHRINK
HIGH POINT BOARD

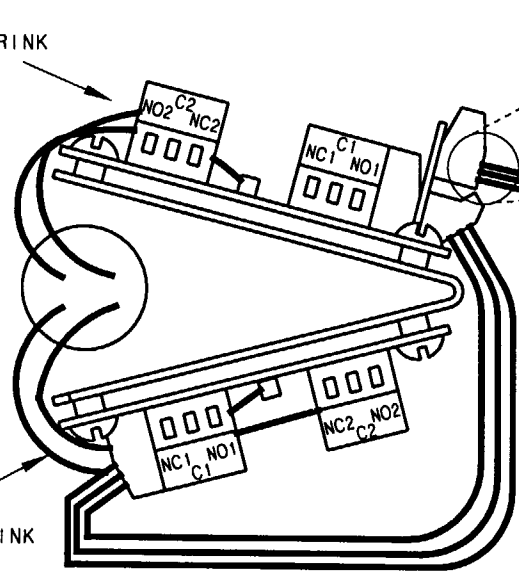

SENSOR WIRE
WITH **BLUE** HEAT SHRINK
LOW POINT BOARD

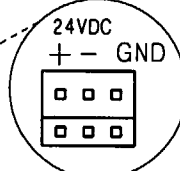

D.C. SUPPLY
24 VDC

NOTE: RECOMMENDED
MAXIMUM #14 AWG
STRANDED WIRE.

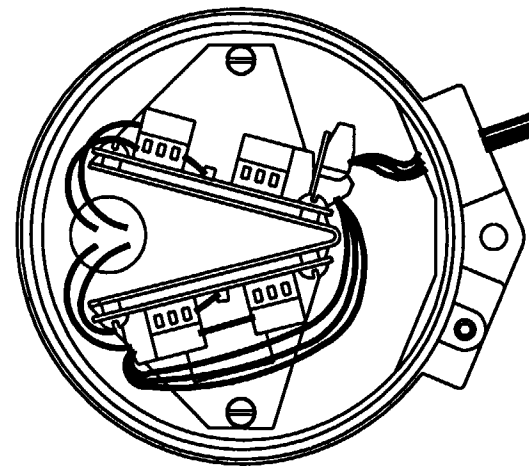

LINE POWER
120/240 VAC
50/60 Hz

CERTIFIED	by _____			COPYRIGHT 1998
PO #	_____			DREXELBROOK ENG CO.
ENG	_____			SCALE NONE
USER	_____			UNLESS OTHERWISE STATED
	2	9-98-244	GLM 10-1-98	ALL DIMENSIONS IN INCHES (MM)
	1	5-96-342	GLM 10-21-96	DR. JJS 9-17-98
DE #	ISS. EDO/DSR NO	APP'D	DATE	CK. ASK



DREXELBROOK
Engineering Company

205 KEITH VALLEY RD
HORSHAM, PA 19044-9986

215-874-1234
FAX 215-874-2731

INTEGRAL 24 VDC
DUAL VERIGAP SWITCH
WIRING

504-1160-1-CD1

SHT 2 OF 2
ISS 2