

DREXELBROOK[®]

Universal IV™ CM Model 2-Wire, 4-20 mA, Water Cut Monitor



Use the Best

For over 50 years, Drexelbrook has established itself as the world's leader in capacitive based water cut measurements. We have done this by providing reliable and accurate products at a reasonable cost. We offer the highest pressure and temperature ratings in the industry. Our probes can handle pressures up to 1500 PSI and temperatures up to 450°F.

Easy Configuration - Now with Built-in LCD Display and Keypad

All Universal IV CM comes from the factory pre-calibrated and requires only one point validation. Field configuration can be done from anywhere along the two-wire loop with our HRTWin PC Software. You can also configure via local display / keypad without the need for laptop or handheld communicators.

Worldwide Approvals

The Universal IV CM Model has been approved for Class I, Div1, and Zone 0 hazardous locations. FM, FMc, ATEX, as well as IECEx approvals are available.

Applications

- Automatic Well Testing (AWT)
- Lease Automatic Custody Transfer (LACT)
- Basic Sediment and Water (BS&W)
- Separation Vessels
- Pipeline Slug Detection
- Truck Unloading
- Pump Protection
- Dielectric Analysis
- Machinery Lube Oil Monitoring

Durability

Our Perm-A-Seal sensing element does not require epoxy coatings that wear out and require expensive servicing. There are no gaskets that require servicing and the sensing element is robust in well fluids that include large amounts of sand.

Eliminate Routine Maintenance

The Universal IV CM (Cut Monitor) is built upon the Drexelbrook expertise in RF Admittance that allows the electronics to ignore paraffin and other coatings that buildup on the probe. No need to take apart spool pieces and tie-off large pipelines. The Universal IV CM can be configured for NPT or flanged mountings and can be installed in common pipe diameters.

0-50% in Light Oil & 0-80% in Heavy Oil

The Universal IV CM comes factory pre-calibrated to one of 11 pre-set ranges, for Light Oil (API Gravity > 25) and Heavy Oil (API Gravity < 25)

Cote Shield™

The proven Cote-Shield is designed into the Universal IV CM series and enables the instrument to ignore a pre-determined length of the sensing element. The ability to ignore a pre-determined length allows the sensing element to extend into the fluid beyond the nozzle mounting, and possible pipe elbows, which can affect the measurement. The Cote-Shield™ puts the sensing area of the insertion probe directly into the process stream and guarantees a more representative sample of the emulsion.

3-YEAR WARRANTY

Analytical Products

Operating Principle

The method of using RF Admittance to measure water cut is widely successful because of the large difference between the dielectric constants of oil ($k \approx 2.3$) and water ($k \approx 80$). The sensing element and the pipe wall form the necessary two surfaces of the concentric capacitor. The system electronics transmit a radio frequency voltage to the sensing element that measures changes in capacitance. As the amount of water in the flowing oil increases, the net dielectric of the fluid increases which causes the capacitance to increase. The onboard electronics will compute the relationship between capacitance change and water cut. Straightforward, Reliable, Proven.

Typical Arrangement

$$\text{Capacitance} = \frac{\text{Dielectric (Area)}}{\text{Distance}} = \frac{KA}{D}$$

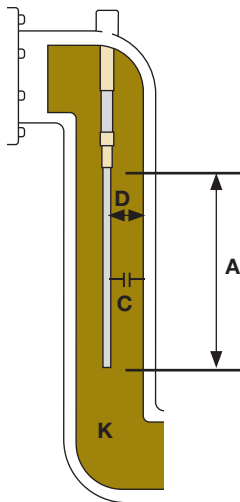

Capacitance Change with Water Content

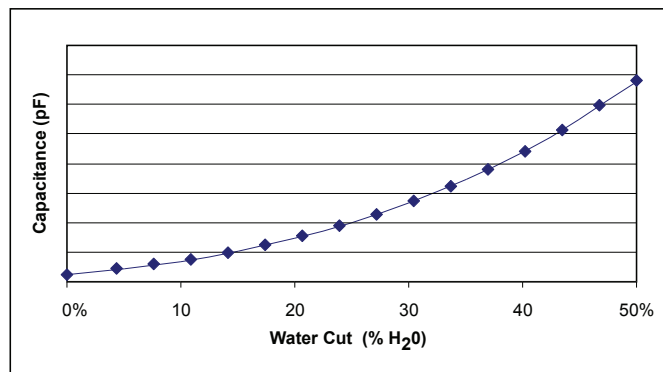

Drexelbrook Sampling Advantage

The Drexelbrook insertion probe design enables it to analyze a large representative sample of the fluid that other manufacturers can not. The Universal IV CM utilizes a sensing element that is unique in its ability to be installed directly into the process without requiring spool pieces, side-arms or slipstreams. The sensing element shown will extend directly into the main process line for a minimum of 15 inches. The advantage of this is the capacitance of the fluid is taken over the entire length of the probe to create an averaging effect. The measurement is now taking a better sample of the fluid over a larger range to produce a smoother, more accurate, response.

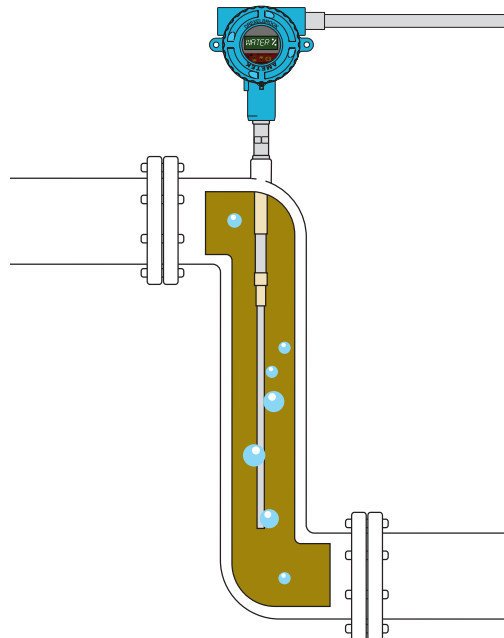

Analytical Products

Sensing Element Selection

The Universal IV™ Cut Monitor sensing element is selected based on pipe size, wetted parts, NACE requirement and pressure/temperature. Pipe sizes of 8" or larger or in tank installations require a concentric shield as well. Below is a selection guide of the standard sensing elements with 3-terminal connection and Cote-Shield™.

Probe Model #	Probe 3-Digit Code	Probe Description	Wetted Parts	Nace Available	Pipe Size	Retrofit IS / Xproof	Pressure / Temperature
700-1202-001	101	3/8" OD active section - Length determined by pipe size With tab connection for remote installations & dual seal	316/316L SS and PEEK*	Yes	Less than 8"	R02 / R12	200 psi at 450F
700-1202-015	104	3/8" OD active section with 1.66" OD Perforated Concentric shield With tab connection for remote installations & dual seal	316/316L SS and PEEK	Yes	In tank	R02 / R12	200 psi at 450F
700-1202-016	251	3/8" OD active section with 1.66" OD Perforated Concentric shield (Integral only)	316/316L SS and PEEK	Yes	In tank	N/A	200 psi at 450F
700-1202-021	253	3/8" OD active section - Length determined by pipe size (Integral only)	316/316L SS and PEEK	Yes	Less than 8"	N/A	200 psi at 450F
700-1202-041	106	3/8" OD active section - Length determined by pipe size With tab connection for remote installations & dual seal	316/316L SS and PEEK	Yes	Less than 8"	R02 / R12	1000 psi at 250F 300 psi at 450F
700-1202-042	256	3/8" OD active section - Length determined by pipe size (Integral only)	316/316L SS and PEEK	Yes	Less than 8"	N/A	1000 psi at 250F 300 psi at 450F
700-1202-045	107	3/8" OD active section with 1.66" OD Perforated Concentric shield With tab connection for remote installations & dual seal	316/316L SS and PEEK	Yes	In tank	R02 / R12	1000 psi at 250F 300 psi at 450F
700-1202-046	257	3/8" OD active section with 1.66" OD Perforated Concentric shield (Integral only)	316/316L SS and PEEK	Yes	In tank	N/A	1000 psi at 250F 300 psi at 450F
700-1202-051	108	3/8" OD active section with Center Rod Stop - Length determined by pipe size. With tab connection for remote installations & dual seal	316/316L SS and PEEK	Yes	Less than 8"	R02 / R12	1500 psi at 250F 500 psi at 450F
700-1202-052	258	3/8" OD active section with Center Rod Stop - Length determined by pipe size (Integral only)	316/316L SS and PEEK	Yes	Less than 8"	N/A	1500 psi at 250F 500 psi at 450F
700-1202-055	109	3/8" OD active section with Center Rod Stop - Length determined by pipe size. Perforated Concentric shield. With tab connection for remote installations & dual seal	316/316L SS and PEEK	Yes	In tank	R02 / R12	1500 psi at 250F 500 psi at 450F
700-1202-061	110	3/8" OD active section with 1.6" OD slotted concentric shield. With tab connection for remote installations & dual seal	316/316L SS and PEEK	Yes	8" and larger	R02 / R12	1000 psi at 250F 300 psi at 450F
700-1202-062	260	3/8" OD active section with 1.66" OD slotted concentric shield (Integral only)	316/316L SS and PEEK	Yes	8" and larger	N/A	1000 psi at 250F 300 psi at 450F
700-1202-081	111	3/8" OD active section with Center Rod Stop - Length determined by pipe size. With 1.66 OD slotted concentric shield. With tab connection for remote installations & dual seal	316/316L SS and PEEK	Yes	8" and larger	R02 / R12	1500 psi at 250F 300 psi at 450F
700-1202-082	261	3/8" OD active section with Center Rod Stop - Length determined by pipe size With 1.66 OD slotted concentric shield (Integral only)	316/316L SS and PEEK	Yes	8" and larger	N/A	1500 psi at 250F 500 psi at 450F
700-1202-0XX (91-403)	112	1" NPT, 3/8" OD active section - Length determined by pipe size Applies to any 700-1202 series. Reduces all lengths by 1.5" With tab connection for remote installations & dual seal"	316/316L SS and PEEK	Yes	Less than 8"	R02 / R12	1500 psi at 250F 500 psi at 450F
700-1202-0XX (91-416)	262	1" NPT, 3/8" OD active section - Length determined by pipe size. Applies to any 700-1202 series. Reduces all lengths by 1.5". (Integral only)	316/316L SS and PEEK	Yes	Less than 8"	N/A	1500 psi at 250F 500 psi at 450F
700-0201-051	328	1/4" OD active section - Length 18.7" fixed by pipe size	316/316L SS and Teflon	Yes	1"	R02	1000 psi at 100F 200 psi at 450F
700-0201-052	329	1/4" OD active section - Length 28.1" fixed by pipe size	316/316L SS and Teflon	Yes	2"	R02	1000 psi at 100F 200 psi at 450F
700-0201-058	330	1/4" OD active section - Length 37" fixed by pipe size. With 1.66" OD slotted concentric shield	316/316L SS and Teflon	Yes	8" and larger	R02	1000 psi at 100F 200 psi at 450F
700-0201-059	331	1/4" OD active section - Length 27" fixed by pipe size. With 1.66" OD Perforated concentric shield	316/316L SS and Teflon	Yes	In tank	R02	1000 psi at 100F 200 psi at 450F
700-0202-053	332	1/2" OD active section - Length 29" fixed by pipe size	316/316L SS and Teflon	Yes	3"	R04	1000 psi at 100F 200 psi at 450F
700-0202-054	333	1/2" OD active section - Length 32.1" fixed by pipe size	316/316L SS and Teflon	Yes	4"	R04	1000 psi at 100F 200 psi at 450F
700-0202-056	334	1/2" OD active section - Length 38.4" fixed by pipe size	316/316L SS and Teflon	Yes	6"	R04	1000 psi at 100F 200 psi at 450F

* PEEK is a high temperature thermoplastic with characteristics similar to TFE but with far better abrasion resistance. PEEK is compatible with the same materials as 316 SS; except for sulfuric acid, methyl ethyl ketone, concentrated phenol, or nitric acid. Consult the factory for questions on additional material compatibility.

Analytical Products

Sensing Element Sizing

The Cut Monitor sensing element varies with pipe size. The larger the pipe diameter size, the longer the sensing element active length must be. The Cote-Shield length is sized so the sensing element is fully extended into the fluid beyond nozzles and elbows. Below are some standard look up tables.

700-1202-0XX Series Sensing Elements		
Pipe Size	Cote-Shield Length	Insertion Length
1½"	3.5"	18.25"
1½"	6"	20.75"
1½"	10"	24.75"
2"	3.5"	21.25"
2"	6"	23.75"
2"	10"	27.75"
3"	3.5"	25.5"
3"	6"	28"
3"	10"	32"
4"	6"	31.125"
4"	10"	35.125"
6"	6"	35.375"
6"	10"	39.375"
8" and >	10"	25.5"
In Tank	3.5"	19"
In Tank	6"	21.5"
In Tank	10"	25.5"

Sensing Element Dimensions

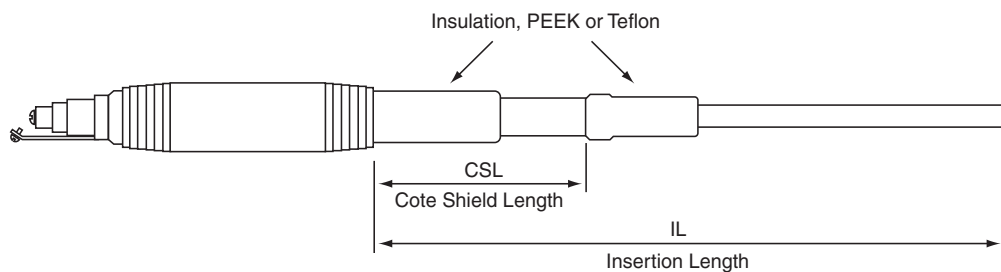

Analytical Products

Integral Mounting / Dimensions - inches (mm)

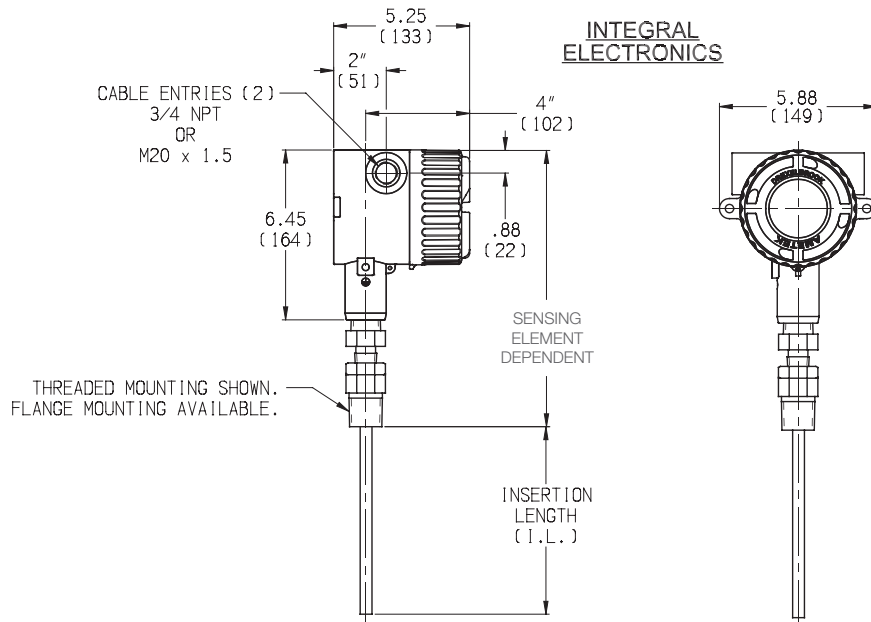

Remote Mounting / Dimensions - inches (mm)

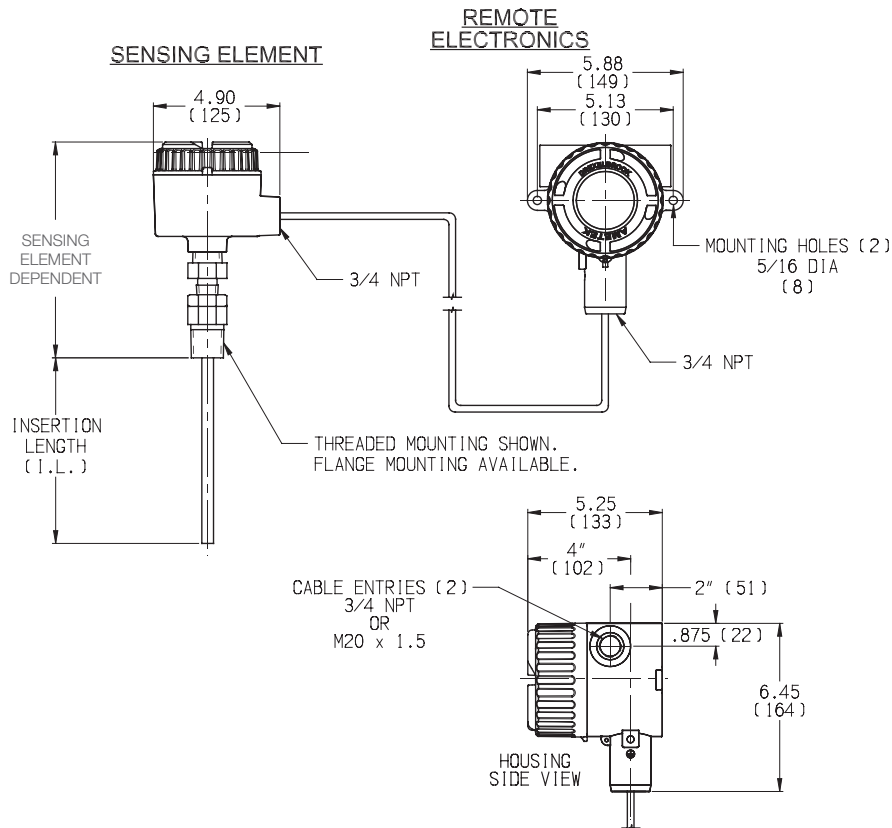

Analytical Products

Specifications

Technology

RF Admittance / Capacitance

Supply Voltage

13-30VDC, 2-wire loop powered

Output/Digital Protocol

4-20mA, HART

Compatible with HART®

Accuracy and Resolution

Water Cut Range	Nominal Water Cut Variance*	Water Cut Resolution**
0 to 1%	+/- 0.03	0.0002
0 to 5%	+/- 0.04	0.0009
0 to 10%	+/- 0.04	0.0009
0 to 30%	+/- 0.12	0.0030
0 to 50%	+/- 0.35	0.0080
0 to 80% (Heavy Oil)	+/- 0.25	0.0035

* The measurement accuracy of an inline, dynamic water cut measurement is dependent upon many process variables including: oil dielectric consistency, fluid velocity at the sample point, mounting geometry and homogeneity of the oil/water emulsion. The values above represent nominal water cut measurement variances for a properly installed sensor under consistent measurement point conditions.

** The smallest water cut step that the instrument can resolve

Load Resistance

Maximum 550 ohms at 24 VDC

Minimum 250 ohms for HART protocol

Ambient Temperature

-40°C to 85°C (-40°F to 167°F)

Process Temperature

Up 232°C (450°F)

Process Pressure

Up 103 bar (1,500 psi), probe dependent

Process Connection

NPT, ANSI, and more upon request

Integral or Remote Configuration

25 ft max cable length for remote configuration

Response Time

350 msec nominal (no damping applied)

1-90 seconds programmable damping time

Supply Voltage Effect

0.2% of full scale max

Temperature Effect

0.5% per 100°F (37.7°C) change

Start-Up Time

< 12 seconds

Configuration and Calibration

Standard LCD display and keypad are built-in

HRTWIN™ PC-based software (free download)

Emission and Surge Protection

Compliant with IEC6100-4.2, 3, 4, 6, 8

Compliant with CISPR11 Group I, Class B

Approvals

Intrinsically Safe (IS)

Explosion Proof (XP) without IS barrier

FM, FMc, ATEX, IECEx

CE Mark



Retrofit Upgrade

The Universal IV CM is backward compatible with Drexelbrook's previous Cut Monitors including CM-6 and CM-3. You can leave your probe in the pipe and upgrade your electronics. Refer to retrofit model R02, R04, and R12.

Start-Up Service

Thousands of cut monitor installations have shown us that the initial start-up of any analytical device is critical. Applications that use the cut monitor for process control and custody transfer demand the most from these devices and can not afford to sacrifice accuracy or reliability.

AMETEK Drexelbrook offers installation and start-up service on all of our cut monitor products. Factory trained service engineers can assist you with the installation, start-up, and calibration of your device.

Analytical Products

Model Numbering - System Electronics and Probe Model

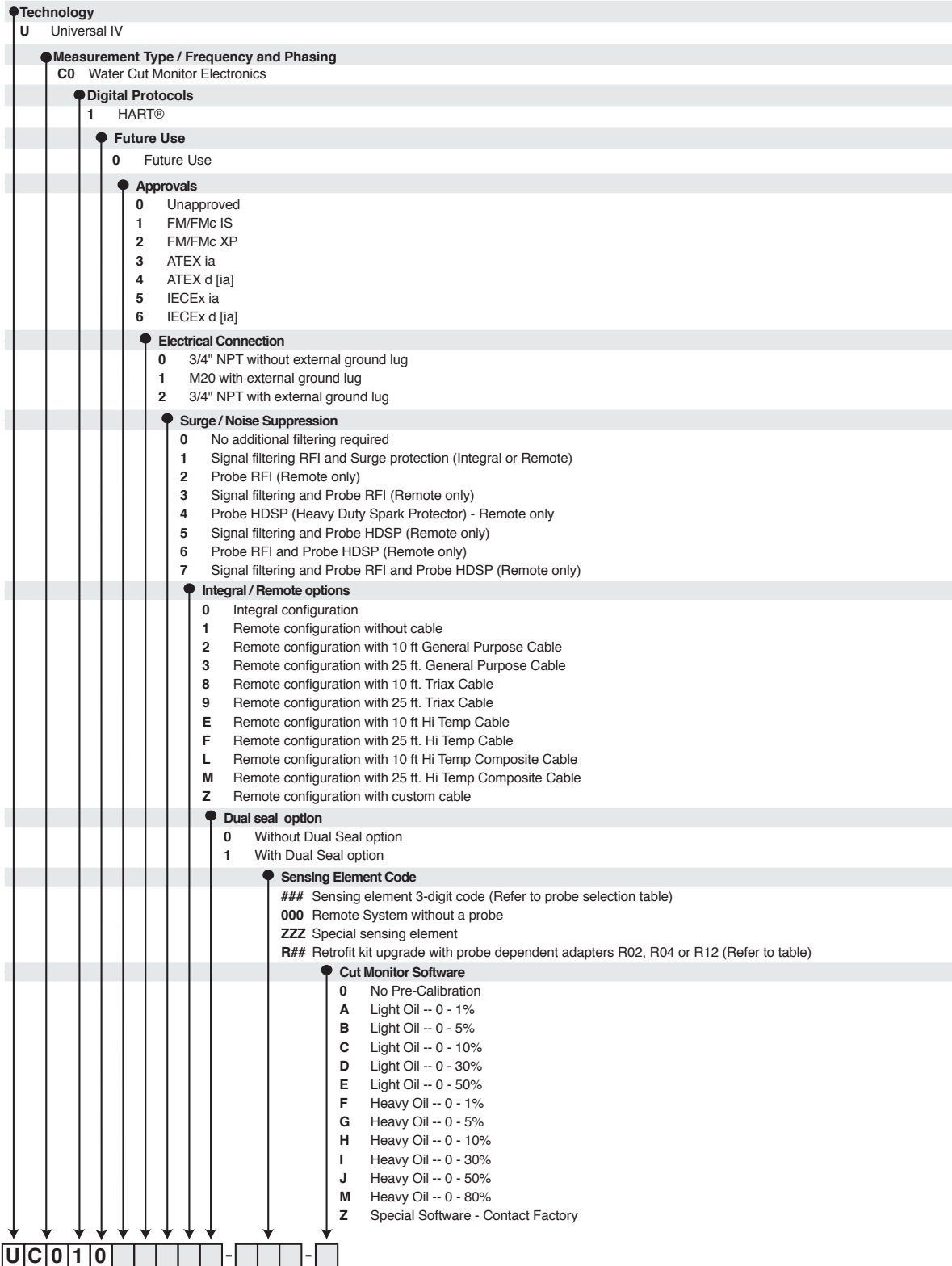

Analytical Products

Model Numbering - Probe Dimensions and Process Connection

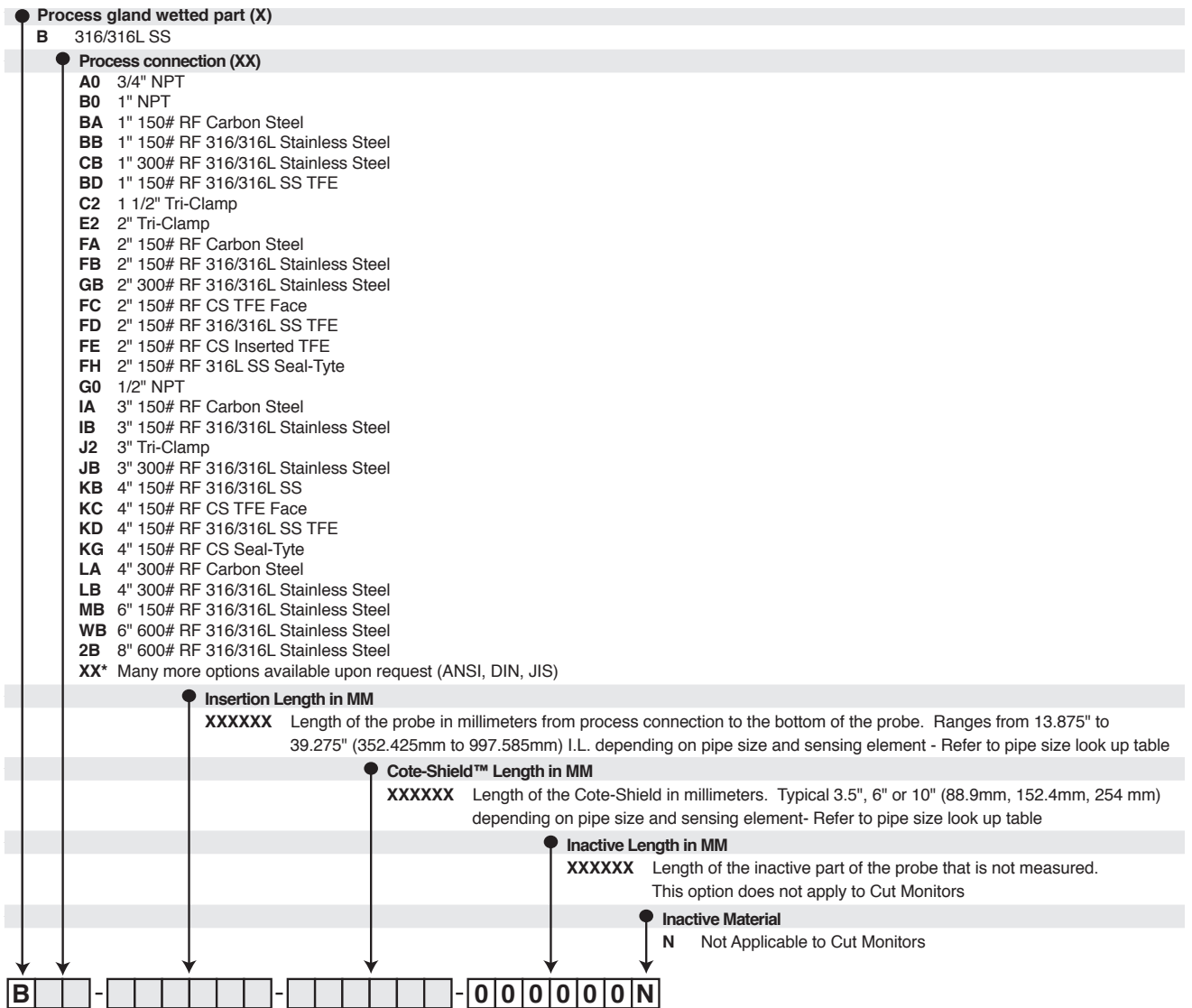

How To Order

To order a Universal IV CM, users must specify the following items:

1. Percentage of Water-In-Oil
2. Approvals Required
3. Integral or Remote Electronics with Cable Length
4. Pipe Size
5. Cote Shield Length
6. Probe Mounting- NPT of Flanged
7. Installation Services
8. Cut Monitor Accessories
9. Pressure & Temperature of Process
10. API Gravity

The model numbering maps show how to place your specifications into our part numbering system. There are two model maps, one for the electronics and one for the probe. Please provide both numbers when ordering.